

# ABES

Art.-Nr.

302 410  
302 413

	1100
	752
	550
	mm

1/4  
VO





	 40 min			 PZ2	 0,5 kg	 3m	 600 mm	 4	 Ø8
--	------------	--	--	---------	------------	--------	------------	-------	--------

ID	EE	ID	Dimensions	Quantity	Ratio
18383		2	228*300*16	3x	1/1
18384		3	228*272*16	3x	1/1
18385		4	550*302*16	3x	1/1
18386		5	730*546*16	1x	1/1
18387		6	730*242*16	1x	1/1
18388		7	1100*550*16	1x	1/1

c.1/1	A 12x	B 6x	C 17x	D 18x	E 18x	F 12x	G 3x	H 4x	J 1x

X	✓	X	✓	X	✓	X	X	X	X

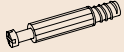
# 2/4 ABES

				
C 17x	D 18x	E 18x	G 3x	H 4x

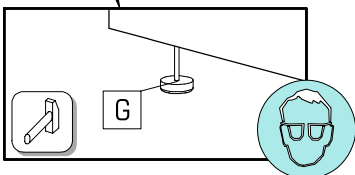
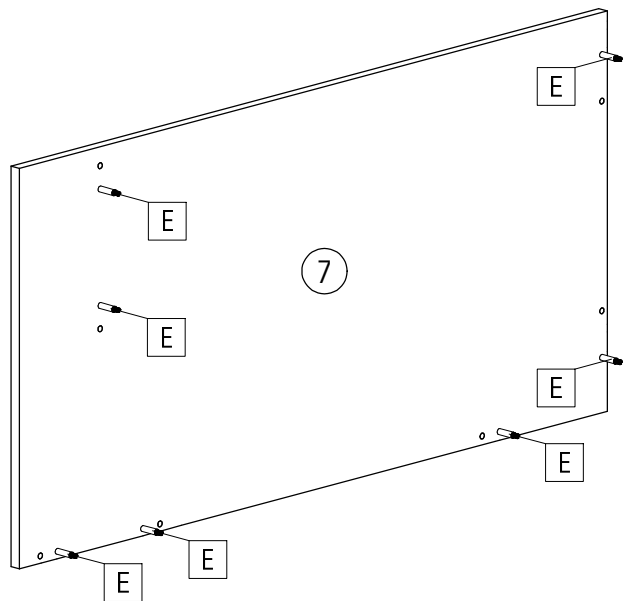
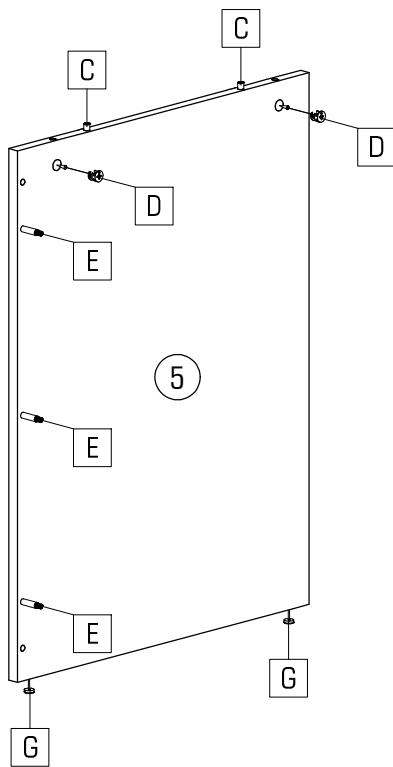
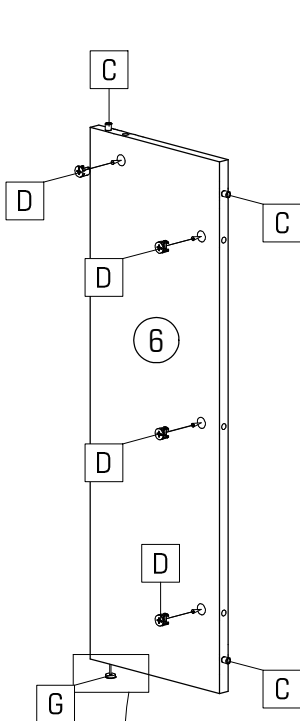
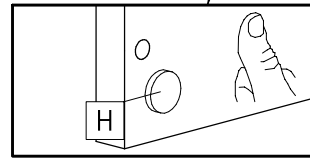
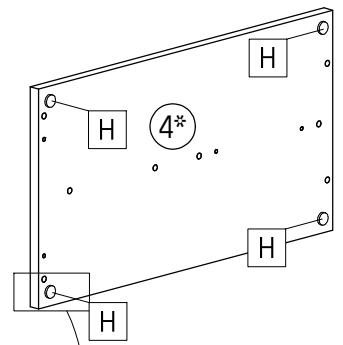
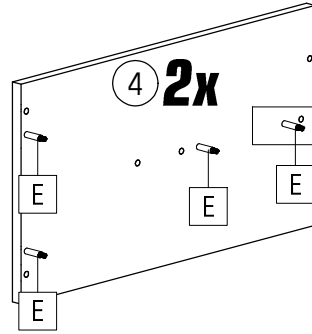
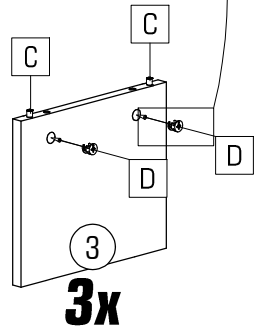
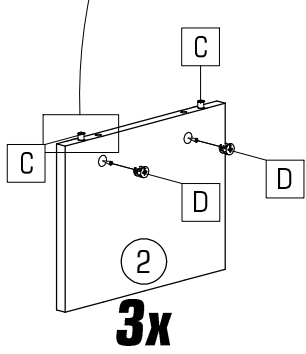
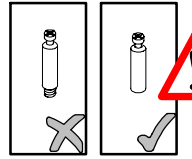
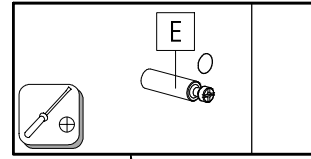
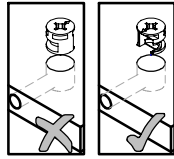
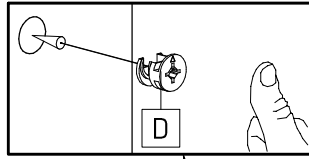
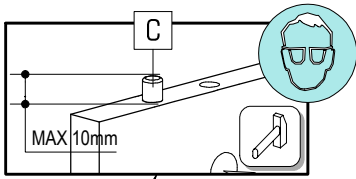

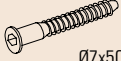
	Ø7x50
F	4x

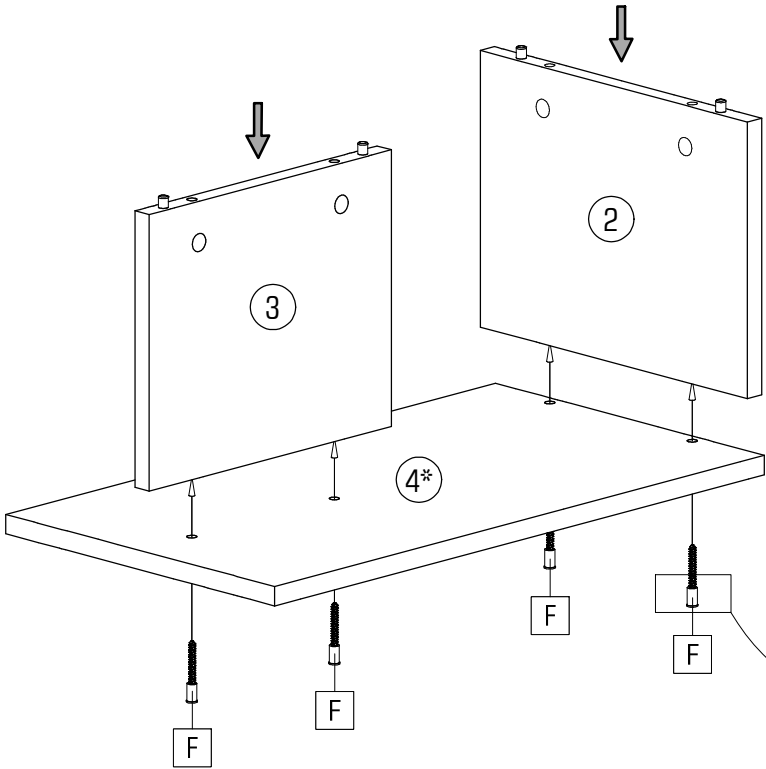

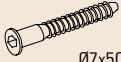
	Ø7x50
F	8x

